

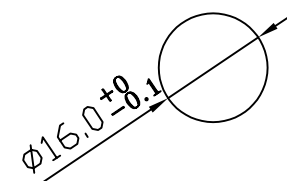

Rating	15A 12VDC		Circuit Structure (ON)---OFF 
Contact R	50m ohm Max.		
Insulation R	DC 500V 100M ohm Min.		
Dielectric Strength	AC 1500V 1 minute		
Circuit	2P OFF-(ON)		

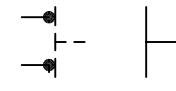
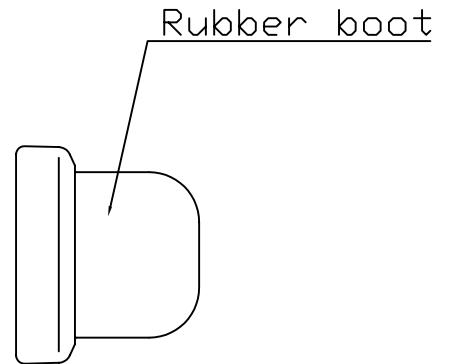
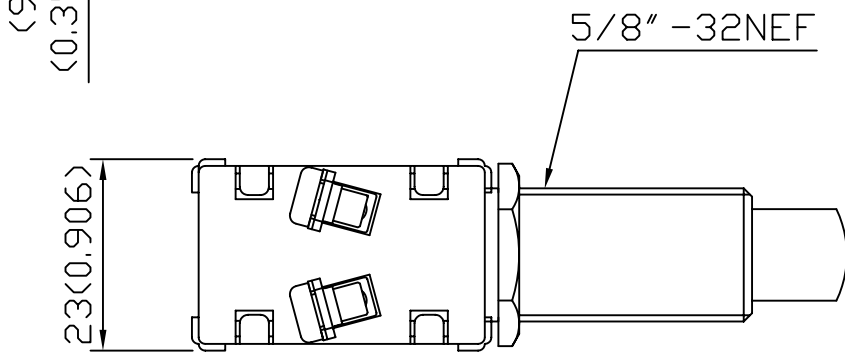
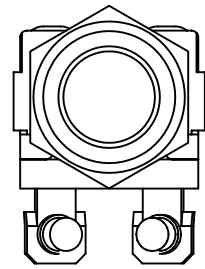
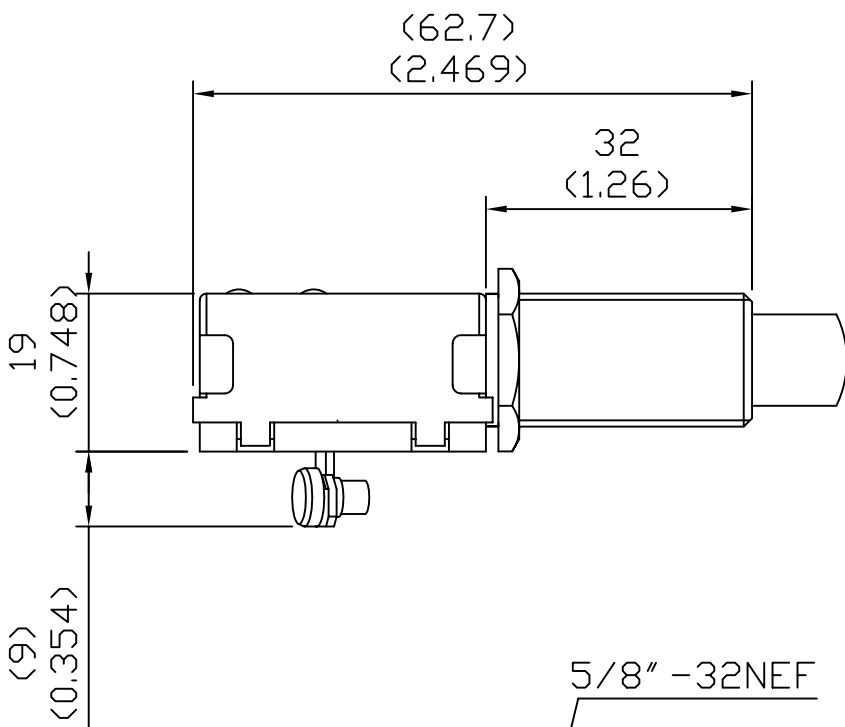

Unit	mm (inch)	DEL CITY P/N	73495	REV.	1	
------	--------------	--------------	-------	------	---	---------------------------------------------------------------------------------------