



RB36V40

Voltage: 38.4 V | Capacity: 40 Ah | Energy: 1536 Wh | Group: 31

LITHIUM IRON PHOSPHATE BATTERY **LiFePO₄**

ELECTRICAL SPECIFICATIONS	
Nominal Voltage	38.4 V
Nominal Capacity	40 Ah
Capacity @ 25 A	96 min
Resistance	≤50 mΩ @ 50% SOC
Efficiency	99%
Self Discharge	<3% per Month
Maximum Batteries Connected in Series	1 (Single Use)

DISCHARGE SPECIFICATIONS	
Maximum Continuous Discharge Current	50 A
Peak Discharge Current	175 A (7.5 s ±2.5 s)
Discharge Over-Current Protection	200A +/- 35A (100 +/- 50ms)
Recommended Low Voltage Disconnect	30.0 V
Discharge Under-Voltage Protection	27.6 V (2.3 ±0.01 vpc)
Reconnect Voltage	30.0 V (2.5 ±0.08 vpc)
Short Circuit Protection Response Time	200-800 μs

TEMPERATURE SPECIFICATIONS	
Discharge Temperature	-4 to 140 °F (-20 to 60 °C)
Charge Temperature*	-4 to 113 °F (-20 to 45 °C)
Recommended Storage Temperature	23 to 95 °F (-5 to 35 °C)
High Temperature Cut-Off	167 °F (75 °C)
Reconnect Temperature	149 °F (65 °C)

*Refer to charge currents below 32°F (0°C)

MECHANICAL SPECIFICATIONS	
Dimensions (L x W x H)	13 x 6.8 x 8.4" 329 x 172 x 214.7 mm
Weight	30.9 lbs (14 kg)
Terminal Type	M8 x 1.25 x 12 mm
Terminal Torque	80 - 100 in-lbs (9 - 11 N-m)
Case Material	ABS & PC blend (UL94-V0 flame rating)
Enclosure Protection (Waterproof Rating)	IP67
Cell Type - Chemistry	Cylindrical - LiFePO ₄

CHARGE SPECIFICATIONS	
Recommended Charge Current	2 A - 8 A
Maximum Continuous Charge Current	40 A
Charge Current 14 to 32 °F (-10 to 0 °C)	≤0.1 C (4 A)
Charge Current -4 to 14 °F (-20 to -10 °C)	≤0.05 C (2 A)
Recommended Charge Voltage	42.6 V - 43.8 V
BMS Charge Voltage Cut-Off	46.2 V (3.85 ±0.025 vpc)
Reconnect Voltage	43.8 V (3.65 ±0.05 vpc)
Balancing Voltage	41.7 V (3.475 vpc)

COMPLIANCE SPECIFICATIONS	
Certifications	UN38.3, CE & UKCA (battery) UL1642 (cells) IEC62133 (cells)
Shipping Classification	UN 3480, CLASS 9

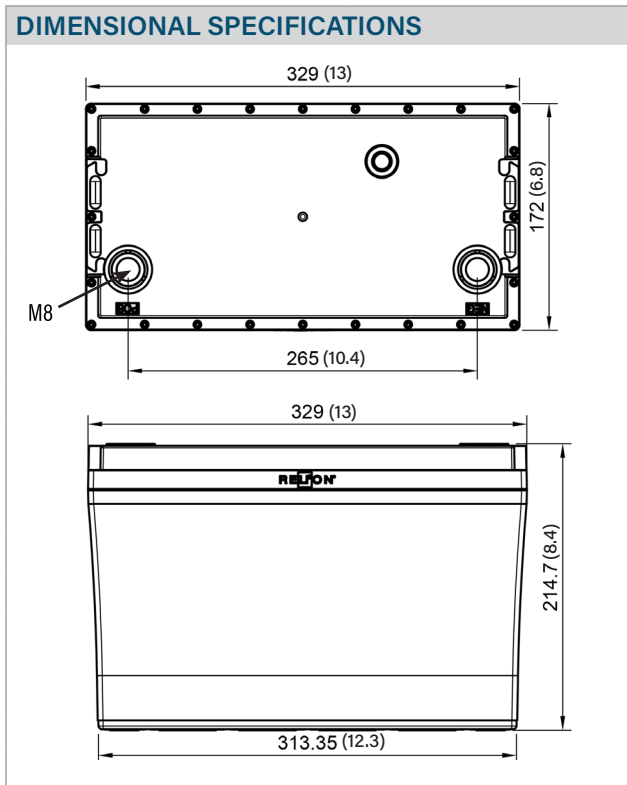



RB36V40

Voltage: 38.4 V | Capacity: 40 Ah | Energy: 1536 Wh | Group: 31

LITHIUM IRON PHOSPHATE BATTERY **LiFePO4**

TYPICAL LITHIUM IRON PHOSPHATE CHARACTERISTICS*

DISCHARGE VOLTAGE CHARACTERISTICS at VARIOUS RATES
25°C (77°F)

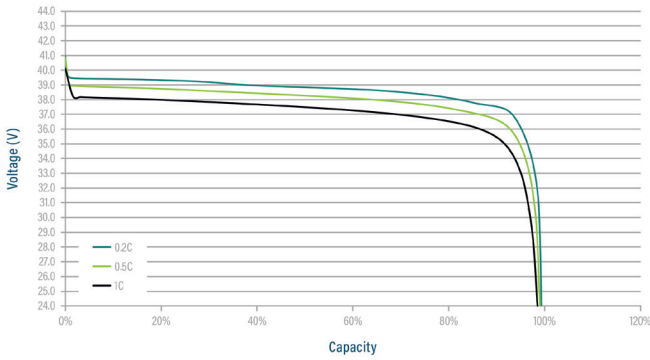

DISCHARGE VOLTAGE CHARACTERISTICS at VARIOUS TEMPERATURES
DISCHARGE 1C

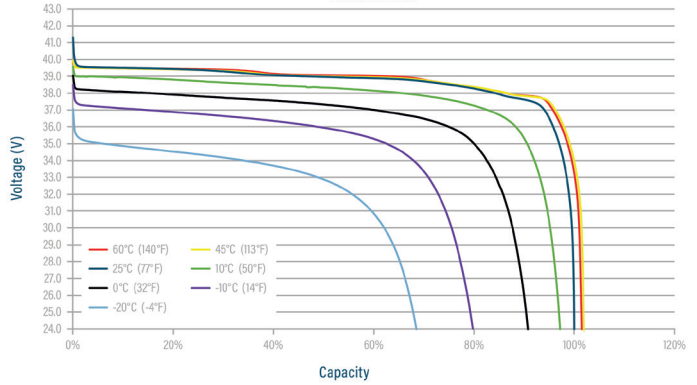

CHARGE VOLTAGE CHARACTERISTICS at VARIOUS TEMPERATURES
CHARGE 0.2C

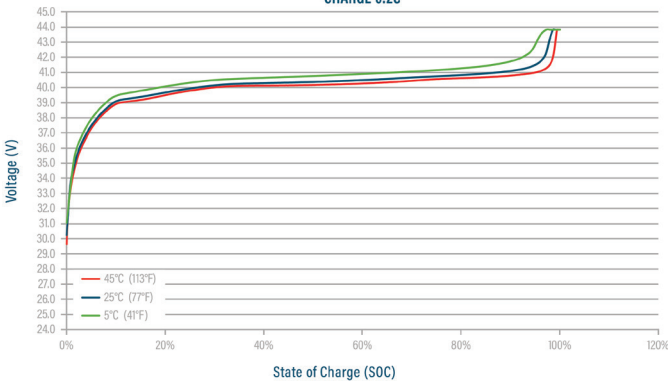

CHARGE VOLTAGE and STATE OF CHARGE (SOC)
CHARGE 0.2C @ 25°C (77°F)

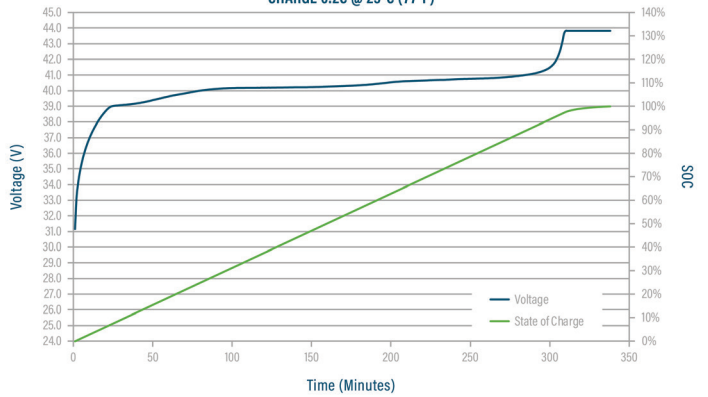

CYCLE LIFE VS. DEPTH OF DISCHARGE (DOD) AT 80%
DISCHARGE 0.5C/CHARGE 0.5C @ 25°C (77°F)

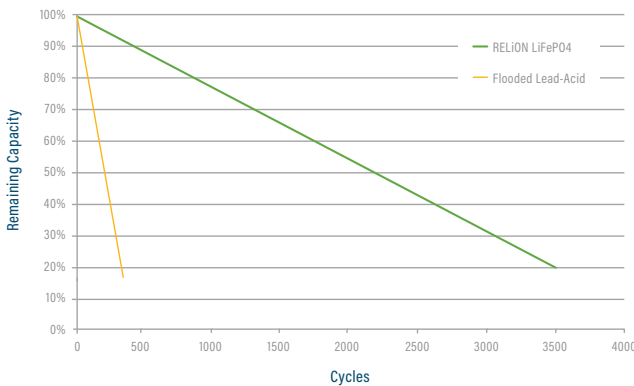

CAPACITY OF RELiON LiFePO4 vs. LEAD ACID
at VARIOUS RATES OF DISCHARGE

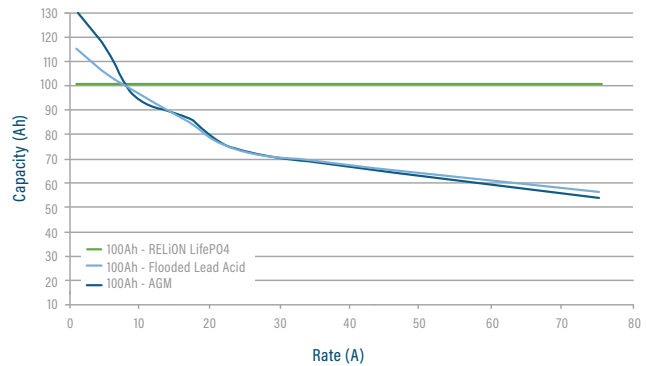

*Performance between applications and batteries may vary. All results should be independently verified by customer.

